



CABLE

SATELLITE

TELECOM

TERRESTRIAL

## TCM470/DCM475 - Digital Cable Modem

User manual

**THOMSON**

**CAUTION**  
Disconnect power  
before servicing.

## CAUTION

To ensure reliable operation and to prevent overheating, provide adequate ventilation for this modem and keep it away from heat sources. Do not locate near heat registers or other heat-producing equipment. Provide for free air flow around the cable modem and its power supply.



This symbol means that your inoperative electronic appliance must be collected separately and not mixed with the household waste. The European Union has implemented a specific collection and recycling system for which producers' are responsible.

This appliance has been designed and manufactured with high quality materials and components that can be recycled and reused. Electrical and electronic appliances are liable to contain parts that are necessary in order for the system to work properly but which can become a health and environmental hazard if they are not handled or disposed of in the proper way. Consequently, please do not throw out your inoperative appliance with the household waste.

If you are the owner of the appliance, you must deposit it at the appropriate local collection point or leave it with the vendor when buying a new appliance.

- If you are a professional user, please follow your supplier's instructions.
- If the appliance is rented to you or left in your care, please contact your service provider.

Help us protect the environment in which we live!

**North American Cable Installer** This reminder is provided to call your attention to Article 820.93 of the National Electrical Code (Section 54 of the Canadian Electrical Code, Part 1) which provides guidelines for proper grounding and, in particular, specifies that the cable ground shall be connected to the grounding system of the building as close to the point of cable entry as practical.

## Power Supply Information

The power supply can be unplugged to turn off main power to the cable modem. It should also be easily accessible in an emergency.

## Power Cord Requirement

This product must be operated with the supplied line cord or with a line cord meeting IEC227 H03 VV-F or IEC227 H03 VVH2-F having conductors with a cross-sectional area not less than  $.75\text{mm}^2$ .

# Important Information

## Operating Information

Operating Temperature: 0° to 40° C (32° to 104° F)

Storage Temperature: -20° to 70° C ( -4° to 158° F)

**If you purchased this product at a retail outlet, please read the following:**

## Product Registration

Please fill out the product registration card that came with this product and return it immediately.

Returning the card allows us to contact you if needed.

Keep your sales receipt to obtain warranty parts and service and for proof of purchase. Attach it here and record the serial and model numbers in case you need them. The numbers are located on the back of the product.

Model No. \_\_\_\_\_ Serial No \_\_\_\_\_

Purchase Date: \_\_\_\_\_ Dealer/Address/Phone: \_\_\_\_\_

# Table of Contents

- CHAPTER 1: CONNECTIONS AND SETUP** ..... 1
- INTRODUCTION**..... 1
  - CABLE MODEM FEATURES** ..... 1
  - WHAT’S ON THE CD-ROM**..... 1
  - ACCESSING THE DIAGNOSTICS DISPLAY THROUGH THE CD-ROM**..... 1
  - COMPUTER REQUIREMENTS** ..... 2
- CABLE MODEM OVERVIEW** ..... 3
  - FRONT PANEL**..... 3
  - REAR PANEL**..... 4
  - WALL MOUNTING**..... 5
  - RELATIONSHIP AMONG THE DEVICES**..... 6
  - WHAT THE MODEM DOES** ..... 6
  - WHAT THE MODEM NEEDS TO DO ITS JOB** ..... 6
  - CONTACT YOUR LOCAL CABLE COMPANY**..... 7
- CONNECTING THE CABLE MODEM** ..... 8
  - CONNECTING THE CABLE MODEM TO A SINGLE COMPUTER** ..... 8
  - ATTACHING THE CABLE TV WIRE TO THE CABLE MODEM** ..... 8
  - ETHERNET CONNECTION TO ONE COMPUTER** ..... 9
  - CONNECTING MORE THAN TWO COMPUTERS TO THE CABLE MODEM**..... 10
  - ACTIVATING THE CABLE MODEM** ..... 11
- CHAPTER 2: ADDITIONAL INFORMATION** ..... 12
- FREQUENTLY ASKED QUESTIONS**..... 12
- GENERAL TROUBLESHOOTING** ..... 13
- FCC DECLARATION OF CONFORMITY AND INDUSTRY CANADA INFORMATION** ..... 14
- SERVICE INFORMATION**..... 14
- GLOSSARY** ..... 15

# Chapter 1: Connections and Setup

## Chapter 1: Connections and Setup

### Introduction

---

#### Cable Modem Features

- CableLabs DOCSIS(option)/Cable Europe Labs EuroDOCSIS 1.0/1.1/2.0/3.0 compliant.
- Support Multiple Provisioning Modes.
- Standard RJ-45 connector for 10/100/1000 BaseT Ethernet with auto-negotiation and MDIX functions; Support maximum Ethernet cable length up to 100m (Category 5).
- Support 8 downstream channels and 4 upstream channels.
- Giga tuner design.
- Maximum data rate upstream up to 120 Mbps (Theoretical) and downstream up to 340 Mbps (440 Mbps EuroDOCSIS) (Theoretical).
- Transparent bridging for IP traffic.
- RSA and 56 bit DES data encryption security.
- SNMP network management support.
- Remote operating firmware downloading.
- Support Web pages and private DHCP server for status monitoring.

‡ The following may affect the speed of your cable modem: your computer equipment and configuration (processor speed, amount of RAM, available disk space); the number of programs you are running at the same time; the capacity of your ISP; network traffic levels; the Ethernet device in use on your computer. Your cable company may or may not fully support the speed capabilities of this modem.

#### What's on the CD-ROM

Insert the cable modem CD-ROM into your CD-ROM drive to view troubleshooting tips, the internal diagnostics, and other valuable information.

CD-ROM Contents:

- Electronic file of the instruction book in additional languages
- Usage and troubleshooting tips

#### Accessing the Diagnostics Display through the CD-ROM

A button on the CD-ROM menu called “Look at Diagnostics” (found under the “About My Cable Modem” menu) launches your browser and displays status and diagnostic information stored within the modem in HTML format (if allowed by the cable operator).

# Chapter 1: Connections and Setup

Please note that before this page can be displayed, your PC must receive an IP address assignment from the Cable company's server, over the cable network. You may want to "bookmark" the IP address in your browser after the diagnostics page is displayed.

## Computer Requirements

Personal computer with the following minimum system requirements (note that the minimum requirements may vary by Cable company):

	<b>IBM PC COMPATIBLE</b>	<b>MACINTOSH**</b>
<b>CPU</b>	Pentium preferred	PowerPC or higher
<b>System RAM</b>	16MB (32MB preferred)	24MB (32MB preferred)
<b>Operating System</b>	Windows* 2000/XP/VISTA	Mac OS** 7.6.1 or higher
<b>Available Disk Space</b>	125MB	50MB
<b>Sound Card</b>	Preferred	N/A†
<b>Video</b>	VGA or better (SVGA preferred)	VGA or better (SVGA built-in preferred)
<b>CD-ROM Drive</b>	Required	Required
<b>Ethernet</b>	10BaseT, 100BaseT,1000BaseT	10BaseT, 100BaseT,1000BaseT
	<b>An Ethernet card makes it possible for your computer to pass data to and from the internet. You must have an Ethernet card and software drivers installed in your computer. You will also need a standard Ethernet cable to connect the Ethernet card to your cable modem.</b>	

**\*Windows is a trademark of the Microsoft Corporation.**

**\*\*Macintosh and the Mac OS are trademarks of Apple Computer, Inc.**

# Chapter 1: Connections and Setup

## Cable Modem Overview

### Front Panel

The following illustration shows the front panel of the model:

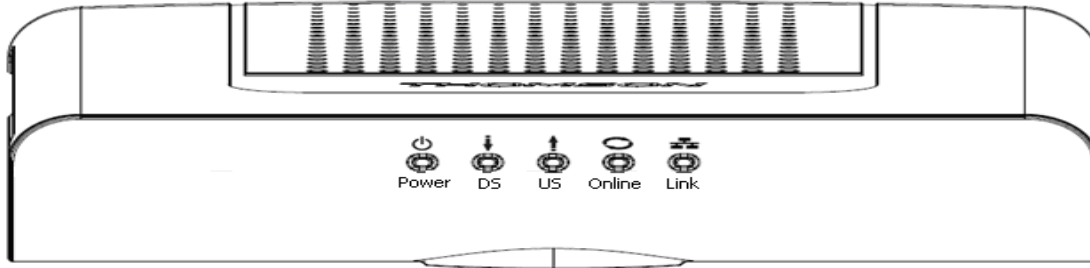

The LEDs on the front panel are described in the table below (from left to right):

DCM475 TCM470	Power	DS	US	ONLINE	LINK	Description
Boot-up Operation	ON	ON	ON	ON	ON	Power on 0.25 sec
	X	FLASH	FLASH	FLASH	X	Following system initialization complete to (before) DS scanning
DOCSIS Start-up Operation	ON	FLASH	OFF	OFF	X	During DS scanning and acquiring SYNC
	ON	ON	FLASH	OFF	X	From SYNC completed, receiving UCD to ranging completed
	ON	ON	ON	FLASH	X	During DHCP, configuration file download, registration, and Baseline Privacy initialization DHCP status, LED SHOULD be ON 1 sec, and OFF 1 sec TFTP status, LED SHOULD be ON 0.25 sec, and OFF 0.25 sec
	ON	ON	ON	ON	X	Operational (NACO=ON)
	ON	FLASH	FLASH	OFF	X	Operational (NACO=OFF)
Channel Bonding Operation	FLASH	FLASH	FLASH	FLASH	FLASH	Wait registration with all DS and all US - Lights Flash sequentially from the <b>right to left</b> Minimum duration 3 seconds
	X	X	X	X	OFF	From 1 to 4 DS, from 1 to 4 LEDs are ON. From 5 to 8 DS, From 1 to 4 LEDs are flashing Duration 3 seconds
	OFF	X	X	X	X	From 1 to 4 US, from 1 to 4 LEDs are ON.
	FLASH	FLASH	FLASH	FLASH	FLASH	Wait registration with all DS and all US - Lights Flash sequentially from the <b>left to right</b> Minimum duration 3 seconds
CPE Operation	X	X	X	X	OFF ON FLASH	No Ethernet Link Ethernet Link TX/RX Ethernet Traffic
SW Download Operation	ON	FLASH	FLASH	ON	X	A software download and while updating the FLASH memory

# Chapter 1: Connections and Setup

## Reset Button behavior

- a) Push and hold the button between 0 and 5 seconds → Reboot the device
- b) Between 6 and 10 seconds → Display the channel bonding status for DS and US  
*Note:* This is the same as the above Channel Bonding display after the registration
- c) After 11 seconds → Perform the factory reset (This operation should only be performed upon your Cable-Operator's request)

## Rear Panel

### TCM470

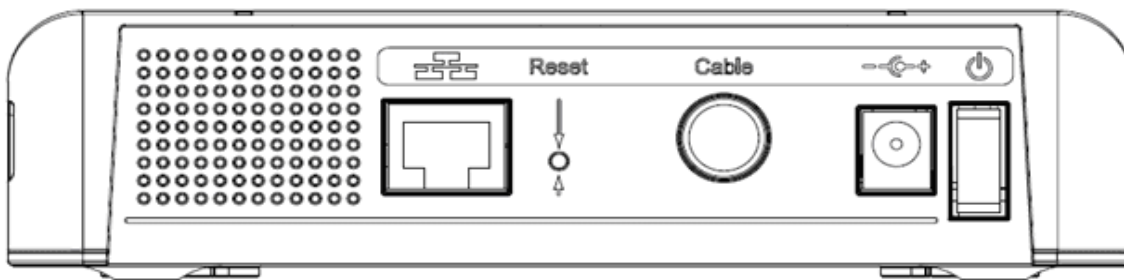

### DCM475

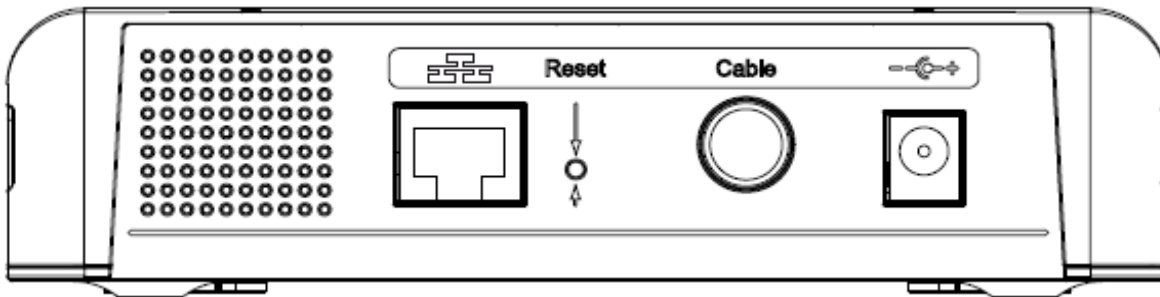

- GIGA ETHERNET: Ethernet 10/100/1000BaseT RJ-45 connector
- RESET: Reset CM
- CABLE: F-Connector
- 12VDC: AC power socket
- on/off button: Power on/off switch ( TCM470 only )



# Chapter 1: Connections and Setup

## Wall Mounting

The number of the screw: 2 pcs

Direction for wall mounting: Tuner downward or leftward or rightward

Dimension for the screw: diameter: 3.5 mm; length: 10 mm

There are 2 slots on the underside of the CABLE MODEM that can be used for wall mounting.

Note: When wall mounting the unit, ensure that it is within reach of the power outlet.

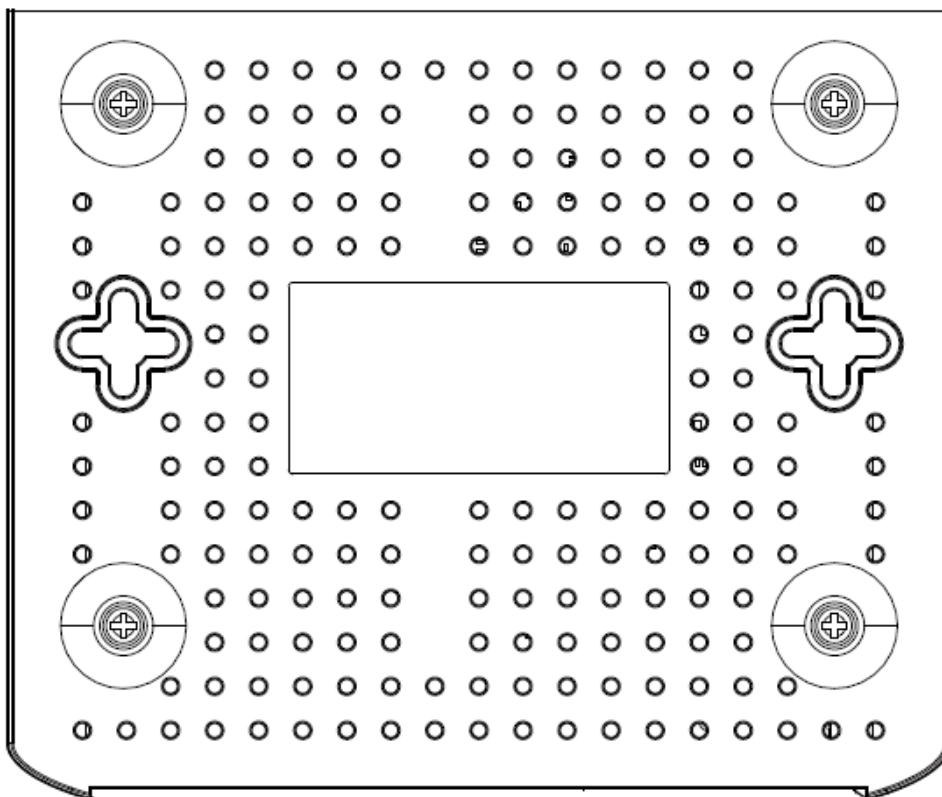

To do this:

1. For THE CABLE MODEM, ensure that the wall you use is smooth, flat, dry and sturdy and use the 2 screws holes
2. The unit can be to use solid concrete wall and/or hard wood wall

# Chapter 1: Connections and Setup

## Relationship Among the Devices

This illustration shows a cable company that offers DOCSIS/Euro-DOCSIS compliant Internet services

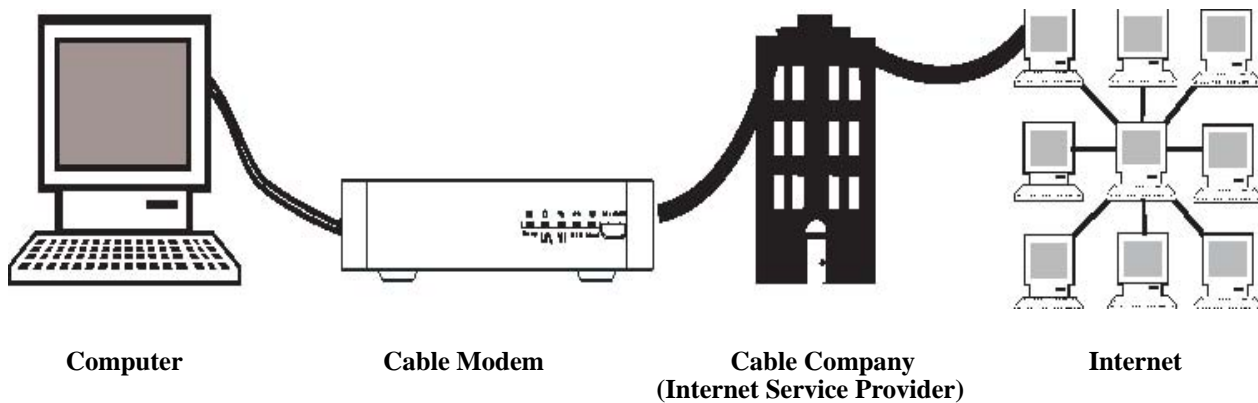

## What the Modem Does

The Thomson digital cable modem serves as a two-way high-speed bridge between your personal computer and a cable Internet Service Provider (ISP). It converts information that originates from the Internet or your computer into electronic messages that can be transported over the same wires your cable company uses to transport video signals.

## What the Modem Needs to Do Its Job

- **The Right Cable Company:** Make sure your local cable company provides data services that use cable industry-standard DOCSIS/Euro-DOCSIS technology compatible with your cable modem.
- **The Internet Service Provider (ISP):** Your cable company provides you access to an Internet Service Provider (ISP). The ISP is your gateway to the Internet. It provides you with a pipeline to access Internet content on the World Wide Web (WWW).

Check with your cable company to make sure you have everything you need to begin; they'll know if you need to install special software or re-configure your computer to make your cable internet service work for you.

# Chapter 1: Connections and Setup

## Contact Your Local Cable Company

You will need to contact your cable company to establish an internet account before you can use your modem. You should have the following information (which you will find on the sticker on the modem) ready:

- The serial number
- The model number of the modem
- The Media Access Control (MAC) address



**Record your information here:**

**Serial Number:** \_\_\_\_\_

**Model Number:** \_\_\_\_\_

**MAC Address:** \_\_\_\_\_

## Please verify the following with the cable company:

- The cable service to your home supports DOCSIS/Euro-DOCSIS compliant two-way modem access.
- Your Internet account has been set up.
- You have a cable outlet near your PC and it is ready for cable modem service.

**Note:** It is important to supply power to the modem at all times. Keeping your modem plugged in will keep it connected to the Internet. This means that it will always be ready when you are.

## Important Information

Your cable company should always be consulted before installing a new cable outlet. Do not attempt any rewiring without contacting your cable company first.

# Chapter 1: Connections and Setup

## Connecting the Cable Modem

### Connecting the Cable Modem to a Single Computer

This section of the manual explains how to connect your cable modem to the Ethernet port on your computer and install the necessary software. Please refer to figure 1 to help you connect your cable modem for the best possible connection.

### Attaching the Cable TV wire to the Cable Modem

1. Locate the Cable TV wire. You may find it one of three ways:
  - A. Connected directly to a TV, a Cable TV converter box, or VCR. The line will be connected to the jack which should be labeled either IN, CABLE IN, CATV, CATV IN, etc.
  - B. Connected to a wall-mounted cable outlet.
  - C. Coming out from under a baseboard heater or other location. See Figure 1 for the wiring example.

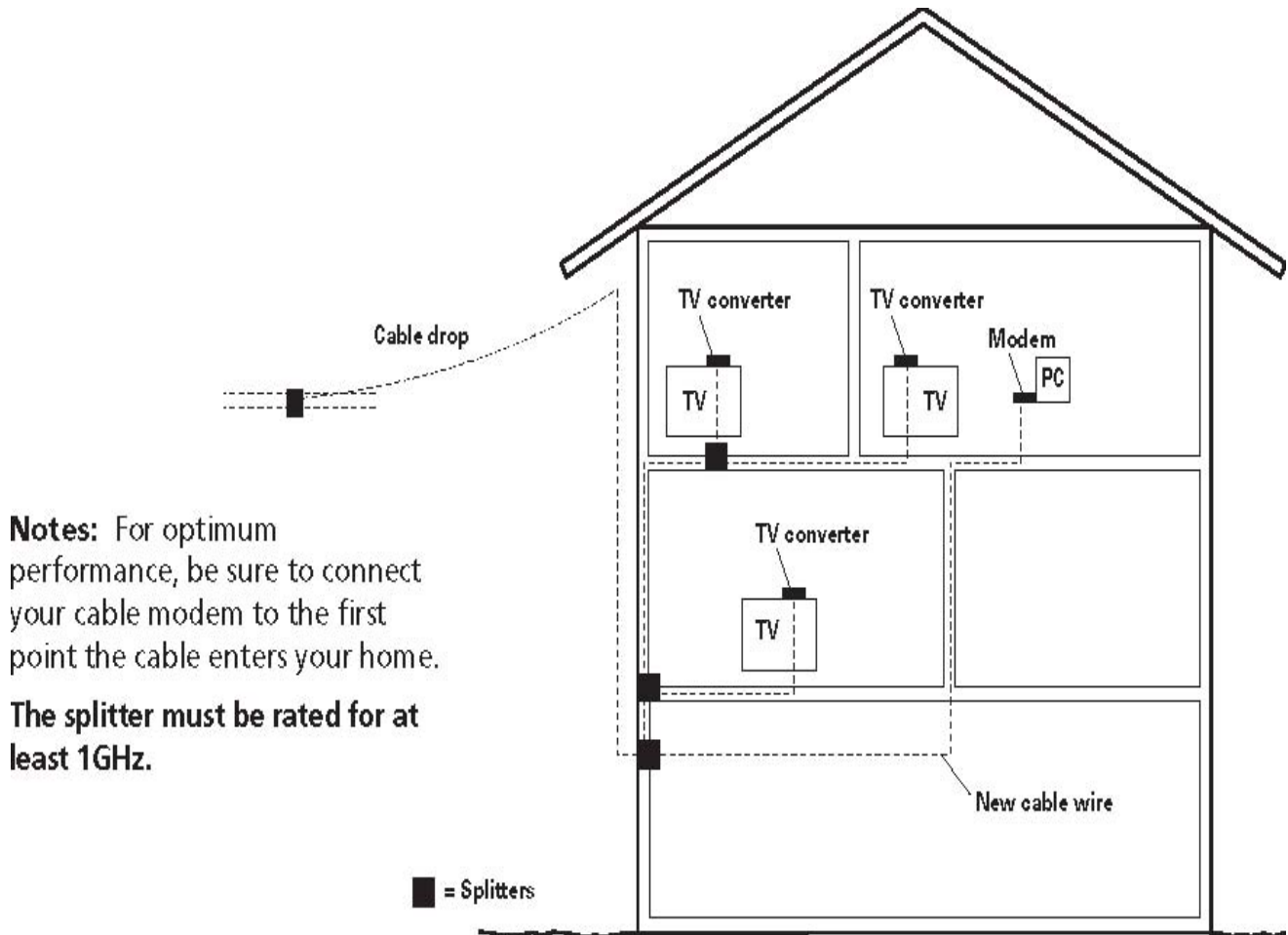

**Notes:** For optimum performance, be sure to connect your cable modem to the first point the cable enters your home.  
**The splitter must be rated for at least 1GHz.**

Fig. 1: Basic Home Wiring

# Chapter 1: Connections and Setup

## Ethernet Connection to One Computer

Make the connections to the modem in the following sequence:

1. Connect one end of the coaxial cable to the cable connection in the wall, and the other end to the connector on the modem labeled “CABLE.”
2. Insert the plug from the AC power supply into the power AC jack on the cable modem and the two-prong plug into the AC outlet.

**Note:** Use only the power supply that accompanied this unit. Using other adapters may damage the unit.

3. Connect one end of the Ethernet cable (straight-wired, see below) to the Ethernet port on the back of your computer, and the other end to the ETHERNET port on the cable modem’s back panel.

Make sure that the Ethernet cable is straight-wired (not “null” or crossover-wired). However, you will need a crossover-type cable if you are connecting the modem to a hub, or a hub within a port switch that provides the same function.

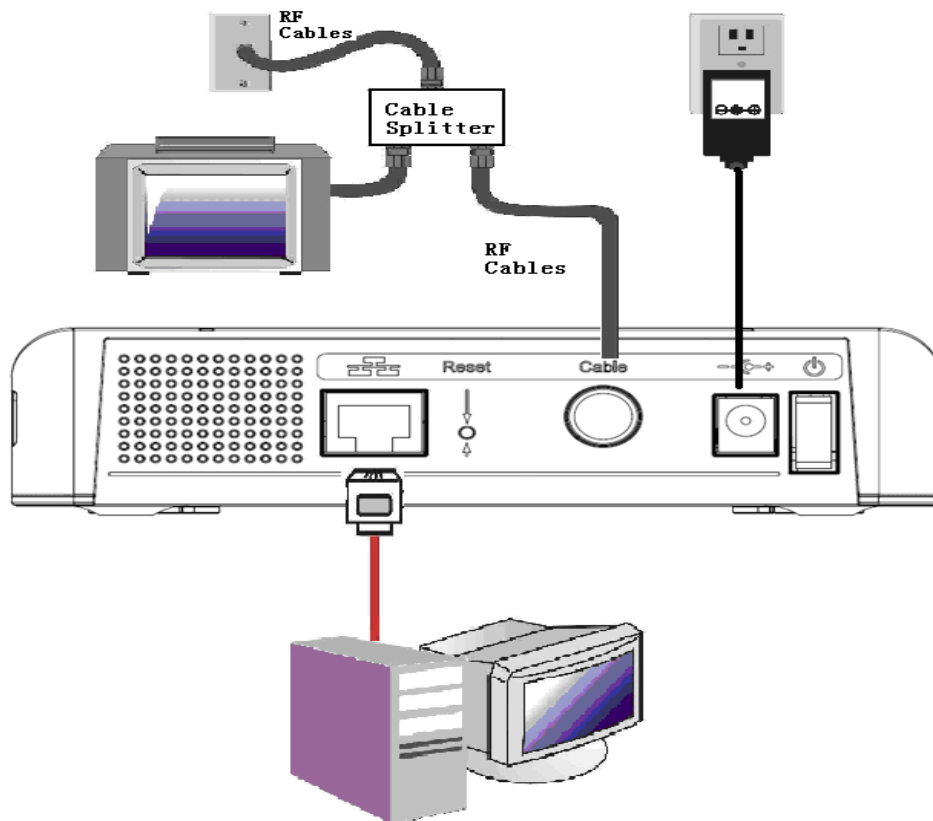

Fig. 2

# Chapter 1: Connections and Setup

## Connecting More Than Two Computers to the Cable Modem

If you need to connect two or more computers, you'll need the following additional equipment (if supported by your cable operator):

- Crossover-wired, or “null,” category 5 Ethernet cable for the cable modem to be connected to the hub
- 10/100/1000BaseT Hub or Switch
- Straight through, or standard, category 5 Ethernet cable (one for each computer to be connected)

If you have a hub with an uplink port, a straight through cable can be used in combination with that port in lieu of the crossover cable.

An uplink port has a small switch on it to change the polarity of the connection. It can accept either a crossover or a straight cable, depending on the setting.

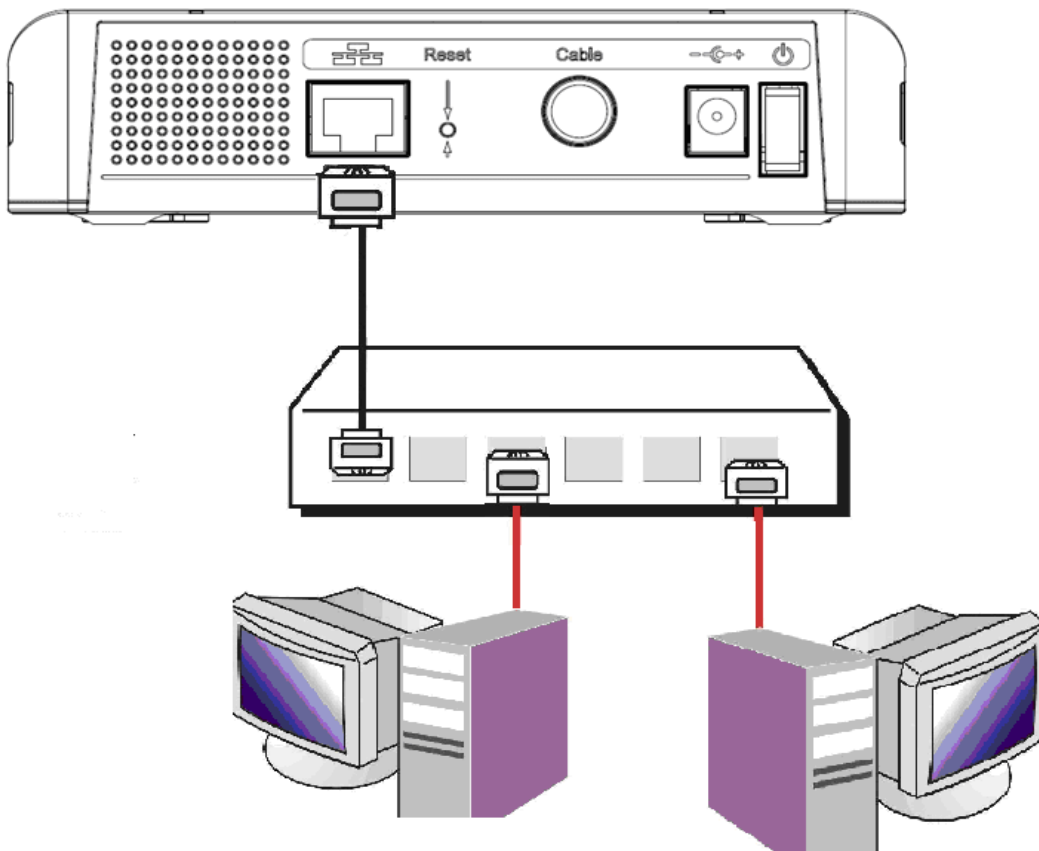

Fig. 3

**Note:** You may need to check with your service provider in order to connect multiple computers.

# Chapter 1: Connections and Setup

## Activating the Cable Modem

---

After you install the cable modem and turn it on for the first time (and each time the modem is reconnected to the power), it goes through several steps before it can be used. Each of these steps is represented by a different pattern of flashing lights on the front of the modem.

**Note:** All indicators flash once prior to the initialization sequence.

If only the LEDs “Power” and “Online” are lit and the LEDs “DS” and “US” are flashing, this indicates the cable modem is automatically updating its system software.. Please wait for the LEDs to stop flashing. You cannot use your modem during this time. Do not remove the power supply or reset the cable modem during this process.

## Chapter 2: Additional Information

### Chapter 2: Additional Information

#### Frequently Asked Questions

---

**Q. *What if I don't subscribe to cable TV?***

- A. If cable TV is available in your area, data service may be made available with or without cable TV service. Contact your local cable company for complete information on cable services, including high-speed internet access.

**Q. *How do I get the system installed?***

- A. Professional installation from your cable provider is strongly recommended. They will ensure proper cable connection to the modem and your computer. However, your retailer may have offered a self installation kit, including the necessary software to communicate with your cable ISP.

**Q. *Once my cable modem is connected, how do I get access to the Internet?***

- A. Your local cable company provides your internet service\*, offering a wide range of services including email, chat, and news and information services, and a connection to the World Wide Web.

**Q. *Can I watch TV and surf the Internet at the same time?***

- A. Absolutely!

**Q. *Can I run more than one computer on the modem?***

- A. Yes – a single cable modem can support up to 32 computers using Ethernet connectivity.

**Q. *What do you mean by “Broadband”?***

- A. Simply put, it means you'll be getting information through a “bigger pipe,” with more bandwidth, than a standard phone line can offer. A wider, “broader” band means more information, more quickly.

**Q. *What is DOCSIS and what does it mean?***

- A. “Data Over Cable Service Interface Specifications” is the industry standard that most cable companies are adopting as they upgrade their systems. Should you ever decide to move, the DOCSIS cable modem will work with all upgraded cable systems that is DOCSIS compliant.

**Q. *What is Euro-DOCSIS and what does it mean?***

- A. Euro-DOCSIS is the modified DOCSIS standard to accommodate European cable systems which often use 8 MHz channel spacing cable networks.



# Chapter 2: Additional Information

## General Troubleshooting

---

You can correct most problems you have with your product by consulting the troubleshooting list that follows.

### **I can't access the internet.**

- Check all of the connections to your modem.
- Your Ethernet card may not be working. Check each product's documentation for more information.
- The Network Properties of your operating system may not be installed correctly or the settings may be incorrect. Check with your ISP or cable company.

### **Two lights are flashing in sequence (DS & US) while 2 others are on (Power & Online).**

- This means the modem is automatically updating its system software. Please wait for the lights to stop flashing. The updating process typically lasts less than one minute.
- Do not remove the power supply or reset the modem during this process.

### **I can't get the modem to establish an Ethernet connection.**

- Even new computers don't always have Ethernet capabilities – be sure to verify that your computer has a properly installed Ethernet card and the driver software to support it.
- Check to see that you are using the right type of Ethernet cable.

### **The modem won't register a cable connection (Online light not on continuously).**

- If the modem is in Initialization Mode, the ONLINE lights will be flashing. Call your Cable Company if it has not completed this 5-step process within 30 minutes, and note which step it is getting stuck on. The modem should work with a standard RG-6 coaxial cable, but if you're using a cable other than the one your Cable Company recommends, or if the terminal connections are loose, it may not work. Check with your Cable Company to determine whether you're using the correct cable.
- If you subscribe to video service over cable, the cable signal may not be reaching the modem. Confirm that good quality cable television pictures are available to the coaxial connector you are using by connecting a television to it. If your cable outlet is "dead", call your Cable Company.
- Verify that the Cable Modem service is DOCSIS/ Euro-DOCSIS compliant by calling your cable provider.

# Chapter 2: Additional Information

## FCC Declaration of Conformity and Industry Canada Information

This device complies with Part 15 of the FCC Rules. Operation is subject to the following two conditions: (1) this device may not cause harmful interference, and (2) this device must accept any interference received, including interference that may cause undesired operation.

Trade Name:	Model: TCM470 / DCM475
Equipment Classification:	Computing Device Accessory
Responsible Party:	Thomson Inc. 101 W. 103 <sup>rd</sup> St. INH700 Indianapolis, IN 46290 USA

This equipment has been tested and found to comply with the limits for a Class B digital device, pursuant to Part 15 of the FCC Rules. These limits are designed to provide reasonable protection against harmful interference in a residential installation. This equipment generates, uses, and can radiate radio frequency energy and, if not installed and used in accordance with the instructions, may cause harmful interference to radio communications. However there is no guarantee that interference will not occur in a particular installation. If this equipment does cause harmful interference to radio or television reception, which can be determined by turning the equipment off and on, the user is encouraged to try and correct the interference by one or more of the following measures:

- Reorient or relocate the receiving antenna.
- Increase the separation between the equipment and receiver.
- Connect this equipment into an outlet on a circuit different from that to which the receiver is connected.
- Consult the dealer or an experienced radio/TV technician for help.

FCC regulations state that unauthorized changes or modifications to this equipment may void the user's authority to operate it.

This Class B digital apparatus meets all requirements of the Canadian Interference Causing Equipment Regulations.

## Service Information

If you purchased or leased your cable modem directly from your cable company, then warranty service for the cable modem may be provided through your cable provider or its authorized representative. For information on 1) Order Service, 2) Obtaining Customer Support, or 3) Additional Service Information, please contact your cable company. If you purchased your cable modem from a retailer, see the enclosed warranty card.

## Chapter 2: Additional Information

### Glossary

---

**10/100/1000BaseT** – Unshielded, twisted pair cable with an RJ-45 connector, used with Ethernet LAN (Local Area Network). “10/100/1000” indicates auto-sensing speed (10 Mbps or 100 Mbps or 1Gbps), “Base” refers to baseband technology, and “T” means twisted pair cable.

**DHCP (Dynamic Host Control Protocol)** – A protocol which allows a server to dynamically assign IP addresses to workstations on the fly.

**DOCSIS (Data Over Cable Service Interface Specifications)** – A project with the objective of developing a set of necessary specifications and operations support interface specifications for cable modems and associated equipment.

**Ethernet card** – A plug-in circuit board installed in an expansion slot of a personal computer. The Ethernet card (sometimes called a Network Interface Card or NIC) takes parallel data from the computer, converts it to serial data, puts it into a packet format, and sends it over the 10BaseT or 100BaseT or 1000BaseT LAN cable.

**F Connector** – A type of coaxial connector, labeled CABLE IN on the rear of the cable modem, that connects the modem to the cable system.

**HTTP (HyperText Transfer Protocol)** – Invisible to the user, HTTP is used by servers and clients to communicate and display information on a client browser.

**Hub** – A device used to connect multiple computers to the cable modem.

**IP Address** – A unique, 32-bit address assigned to every device in a network. An IP (Internet Protocol) address has two parts: a network address and a host address. This modem receives a new IP address from your cable operator via DHCP each time it goes through Initialization Mode.

**MAC Address** – The permanent “identity” for a device programmed into the Media Access Control layer in the network architecture during the modem’s manufacture.

**Network Driver** – A file that is loaded on the computer to allow the computer to recognize the Ethernet card.

**TCP/IP (Transmission Control Protocol/Internet Protocol)** – A networking protocol that provides communication across interconnected networks, between computers with diverse hardware architectures and various operating systems.

## Chapter 2: Additional Information

### Applicable power supplies list:

- a) Global Yeou Diann Electric Industrial Co., Ltd.
  - AMS6-1201000SV (Europe Plug)
  - AMS6-1201000SB (United Kingdom Plug or Singapore Plug)
  - AMS6-1201000SS (Australian Plug or Korea Plug)
  - AMS6-1201000SC (China Plug)
  - AMS6-1201000SR (Russia Plug)
  - AMS6-1201000SI (India Plug)
  - AMS6-1201000SA (Argentina Plug)
  - AMS6-1201000SX (Brazil Plug)
  - AMS6-1201000SH (Thailand Plug)
  - AMS6-1201000SU (US Plug)
  
- b) Leader Electronics Inc.
  - MV12-Y120100-A2 (Europe Plug)
  - MV12-Y120100-B2 (United Kingdom Plug)
  - MV12-Y120100-C5 (China Plug)
  - MT12-Y120100-A1 (US Plug)

---

Please do not send any products to the Indianapolis address listed in this manual or on the carton. This will only add delays in service for your product.

**Thomson Inc.**  
101 W. 103<sup>rd</sup> St., INH700  
Indianapolis, IN 46290  
USA

For more information

Thomson | 46, quai Alphonse Le Gallo | 92100 Boulogne-Billancourt | France  
Tel. : 33 (0) 1 41 86 50 00 | Fax : 33 (0) 1 41 86 56 59 | [www.thomson-broadband.com](http://www.thomson-broadband.com)

© 2007 Thomson Inc.- Trademark(s) ® Registered\ -Marca(s) Registrada(s)\  
Photos and features subject to change without notice.  
Illustration of product finish may vary from actual color.

**THOMSON**